

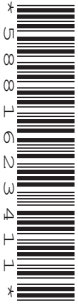

Cambridge Primary Progression Test

Mathematics paper 3 learner answer sheet

Stage 4



approx. 15 minutes

Name

No additional materials are allowed.

READ THESE INSTRUCTIONS FIRST

Answer **all** questions in the spaces provided.

Calculators are **not** allowed.

Each question is worth 1 mark.

The total number of marks is 20.

For Teacher's Use	
Total	

Time: 5 seconds

1

2 cents

3 1346

4

5 

6 metres

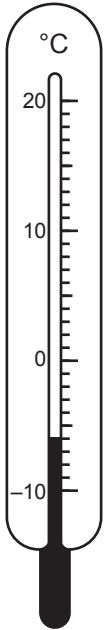
7 
 °C

8 14 26 34 36

9 pages 75

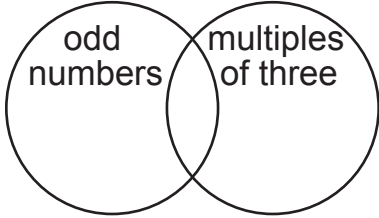
10 

11 $84 \div \text{[]} = 14$

12 °

13 35

14 stickers 70

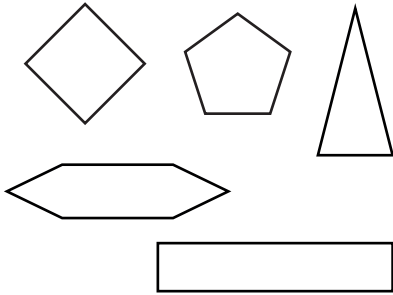
15 

Time: 10 seconds

16		364	<input type="text"/>
----	--	-----	----------------------

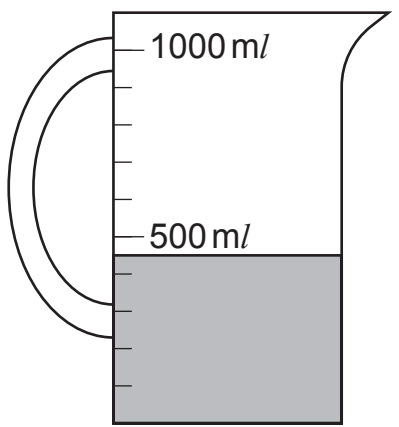
17		ml <input type="text"/>
----	---	-------------------------

18		China	Australia	United States	France	
	Gold	38	8	46	11	
	Silver	29	15	28	11	
	Bronze	21	12	29	12	
	China	Australia	United States	France	<input type="text"/>	

19	cm	30 cm	<input type="text"/>
----	----	-------	----------------------

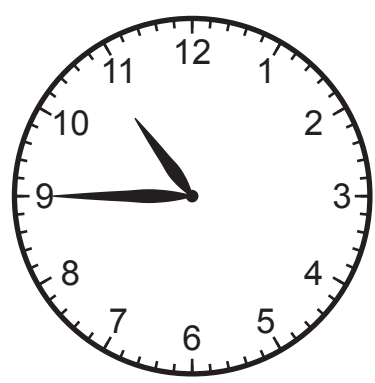
20		<input type="text"/>
----	---	----------------------

